

MINIMUM 90 MILS OF POLYGUARD DETAIL SEALANT PW OR POLYGUARD LM-95 APPLIED TO CLEAN, DRY AND FROST FREE CONCRETE AND THE TOP EDGE OF THE TERMINATION STRIP, OVER EACH FASTENER HEAD TO AND ONTO 1" OF HDPE BELOW THE TERMINATION STRIP ALL SURFACES PREPARED WITH POLYGUARD 650 LT LIQUID ADHESIVE OR POLYGUARD CALIFORNIA SEALANT APPLIED AT A RATE OF 250 - 300 SF/GAL

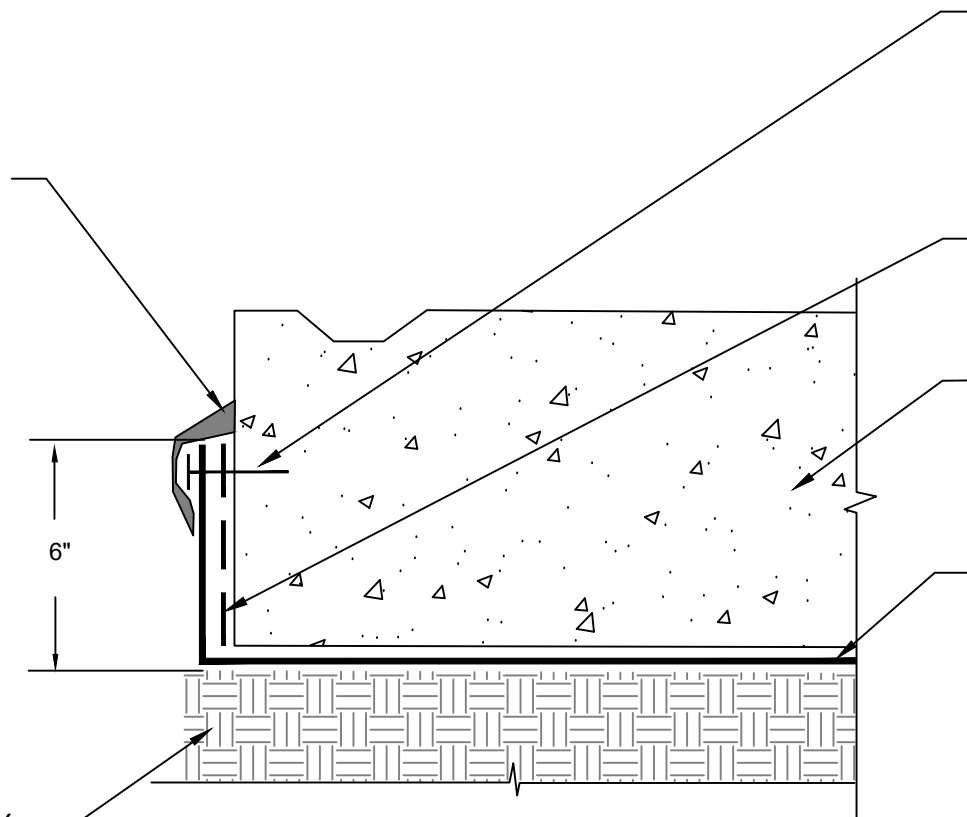

TERMINATION BAR AND FASTENERS SPACED 2" INWARD FROM EACH END OF TERMINATION STRIP AND NOT MORE THAN 8" SPACING BETWEEN FASTENERS - BY OTHERS

POLYGUARD 606 TAPE APPLIED TO CLEAN, DRY AND FROST FREE CONCRETE PREPARED WITH POLYGUARD 650 LT LIQUID ADHESIVE OR POLYGUARD CALIFORNIA SEALANT APPLIED AT A RATE OF 250 - 300 SF/GAL

EXISTING CONCRETE - BY OTHERS

CONTINUOUS POLYGUARD UNDERSLAB MEMBRANE EXTENDED BEYOND FACE OF FOOTER / SLAB FOR ADHERING TO POLYGUARD 606 TAPE. PREPARE FABRIC OF POLYGUARD UNDERSLAB MEMBRANE WITH POLYGUARD 650 LT LIQUID ADHESIVE OR POLYGUARD CALIFORNIA SEALANT APPLIED AT A RATE OF 50 - 75 SF/GAL & SET WET ONTO POLYGUARD 606 TAPE

APPROVED SUBSTRATE - BY OTHERS

US7

SECTION @ POST CONCRETE POUR TERMINATION TO FACE OF FOOTER - STRUCTURAL SLAB

Polyguard Products, Inc.
P.O. Box 755 - Ennis, TX 75120
Phone: 214-515-5000
Web Site - www.polyguard.com

©POLYGUARD PRODUCTS, INC.
MATERIAL SEPARATED FOR CLARITY

<small>The information provided is based on data and knowledge considered to be true and accurate and is offered for the users' consideration, investigation and verification, but we do not warrant the results to be obtained. Please read all data sheets, statements, recommendations or suggestions in conjunction with our conditions of sale, which apply to all goods supplied by us.</small>	NOT TO SCALE
	EFFECTIVE DATE: 10/01/2022
	SUPERCEDES: 02/01/2022