

POLYGUARD DETAIL SEALANT PW OR POLYGUARD LM95 APPLIED TO THE TOP OF THE TERMINATION BAR AND COVERING A MINIMUM 1/8" BEYOND PERIMETER OF FASTENER HEADS

1/8" X 1" METAL TERMINATION BAR FASTENED AT 8" SPACING AND 2" FROM EACH END - BY OTHERS

3/4" FILLET OF POLYGUARD DETAIL SEALANT PW OR POLYGUARD LM-95 APPLIED TO RAW CONCRETE

SUBSTRATE

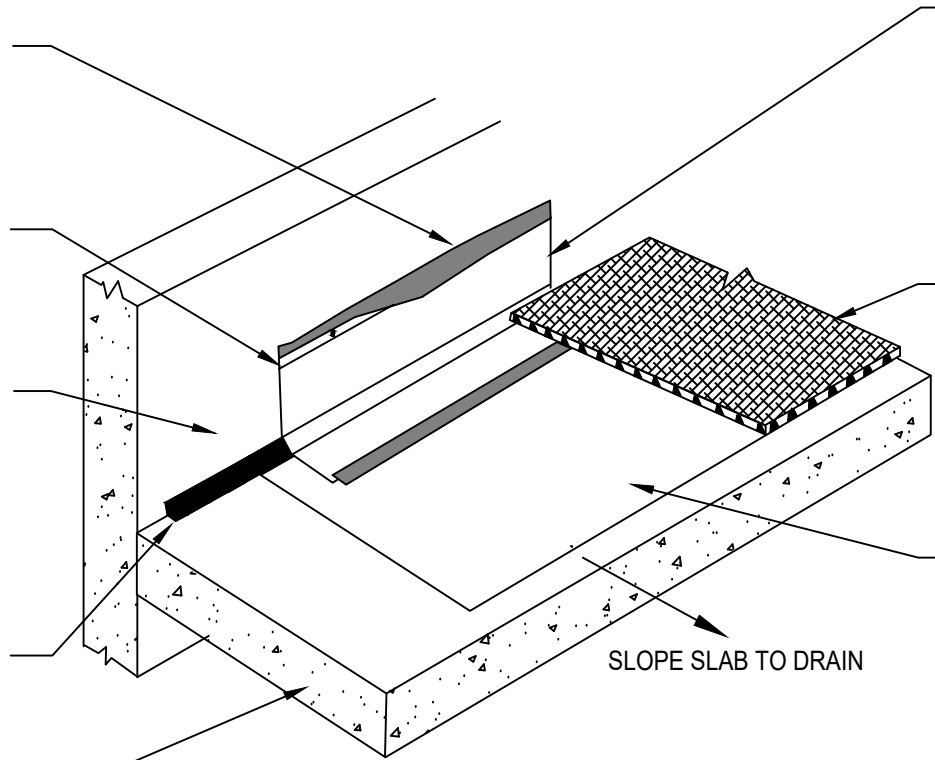

12" POLYGUARD DETAIL TAPE APPLIED TO INSIDE AND OUTSIDE CORNERS PREPARE VERTICAL SUBSTRATE WITH POLYGUARD 650 LT LIQUID ADHESIVE OR POLYGUARD CALIFORNIA SEALANT AT A RATE OF 250 - 300 SF/GAL OR POLYGUARD 650 WB LIQUID ADHESIVE AT A RATE OF 350-400 SF/GAL AND ONTO EXISTING HORIZONTAL POLYGUARD 650 MEMBRANE

POLYGUARD POLYFLOW 18 SHEET MOLDED DRAIN OR PROTECTION - WOVEN MESH FACING TOPPING SLAB

POLYGUARD 650 MEMBRANE APPLIED TO HORIZONTAL SUBSTRATE PREPARED WITH POLYGUARD 650 LT LIQUID ADHESIVE OR POLYGUARD CALIFORNIA SEALANT AT A RATE OF 250 - 300 SF/GAL OR POLYGUARD 650 WB LIQUID ADHESIVE AT A RATE OF 350 - 400 SF/GAL - TERMINATING AT THE FILLET - SLOPE TO DRAIN

SLOPE SLAB TO DRAIN

WP7

OVERVIEW @ HORIZONTAL SLAB AT WALL TERMINATION

Polyguard Products, Inc.
P.O. Box 755 - Ennis, TX 75120
Phone: 214-515-5000
Web Site - www.polyguard.com

SPECIAL NOTE: IF ADHESIVE IS REQUIRED FOR SEAMS OR ENDLAPS DO NOT USE POLYGUARD 650 WB LIQUID ADHESIVE

©POLYGUARD PRODUCTS, INC.
MATERIAL SEPARATED FOR CLARITY

<small>The information provided is based on data and knowledge considered to be true and accurate and is offered for the users' consideration, investigation and verification, but we do not warrant the results to be obtained. Please read all data sheets, statements, recommendations or suggestions in conjunction with our conditions of sale, which apply to all goods supplied by us.</small>	NOT TO SCALE
	EFFECTIVE DATE: 10/01/2022
	SUPERCEDES: 01/17/2022